

SE37X - KIT AERODINÁMICO

CONFIGURACIÓN CONCESIONARIO

- 01 Parachoques anterior
- 02 Parachoques posterior
- 03 Taloneras
- 04 Spoiler

SE37X - KIT AERODINÁMICO

REFERENCIAS EN ESTADO DE SUMINISTRO

REFERENCIA	PIEZA	SENSOR PARKING	LAVAFAROS	RECORTE ESCAPE	COLOR	IMITACIÓN ANTINEBLA	DISTANCIAL TRAVIESA	DECOR. ESCAPE
5F0.071.060	Parach ant.	NO	NO		Imprimado	NO	BASIS y FR	
5F0.071.060.A	Parach ant.	NO	SI		Imprimado	NO	BASIS y FR	
5F0.071.609	Parach post.	NO		Sin recorte	Imprimado			FR y KIT (2)
5F0.071.610	Talonera 5P				Imprimado			
5F0.071.610.A	Talonera 3P				Imprimado			
5F0.071.606.A	Spoiler 5P				Imprimado			
5F0.071.606.B	Spoiler 3P				Imprimado			

/ Decorativos parachoques



Enmascarar

Decorativo frontal: Desmontado



Enmascarar

Decorativo escape: Desmontado

SE37X - KIT AERODINÁMICO

CONFIGURACIÓN CONCESIONARIO

01 Parachoques anterior

02 Parachoques posterior

03 Taloneras

04 Spoiler

SE37X - KIT AERODINÁMICO

PARACHOQUES ANTERIOR SIN LAVAFAROS – 5F0.071.060

/ Componentes

INCLUYE INSTRUCCIONES DE
MONTAJE Y TORNILLERIA

Componentes
imprimados

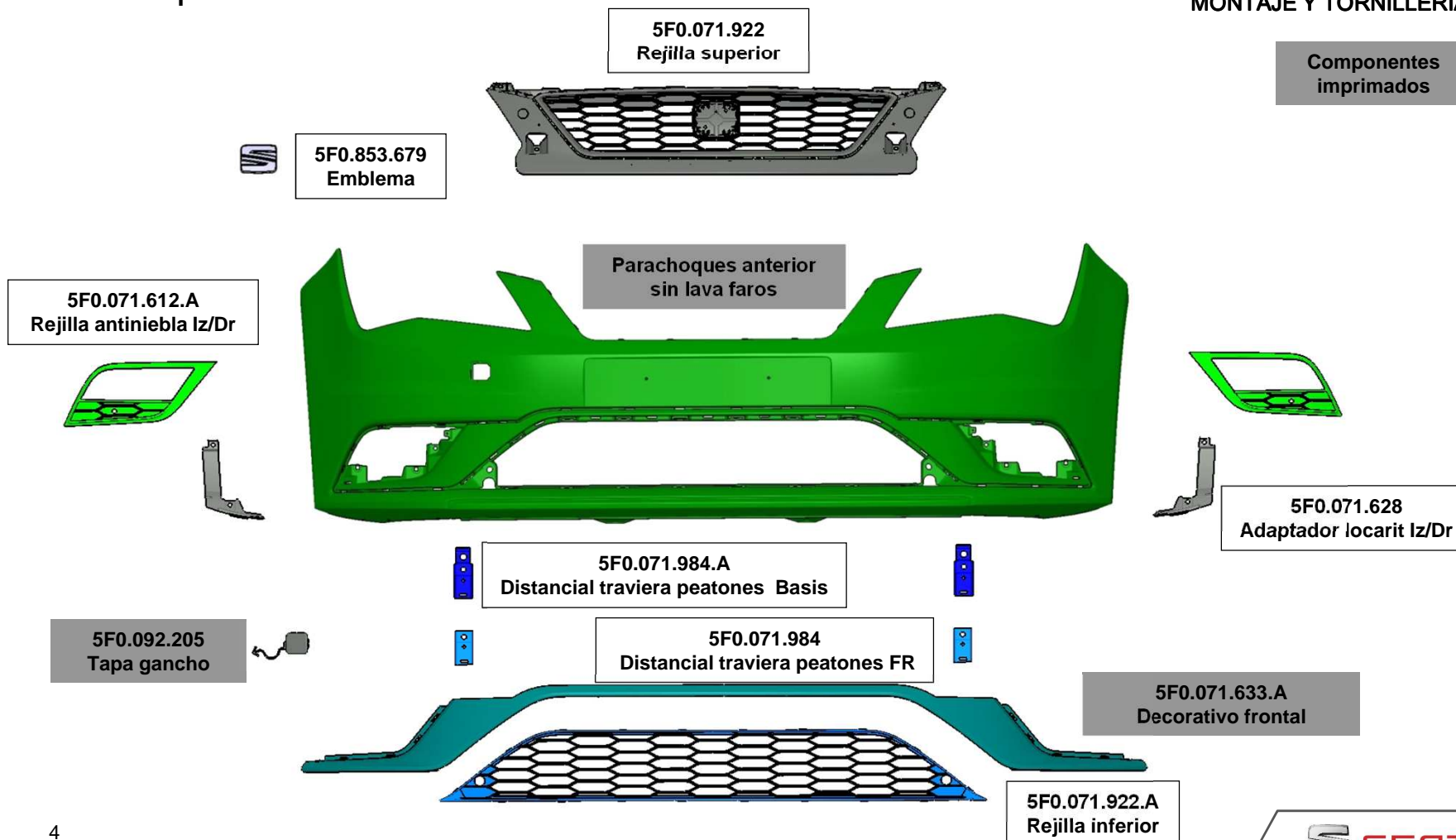

SE37X - KIT AERODINÁMICO

CONFIGURACIONES PARACHOQUES ANTERIOR – 5F0.071.060

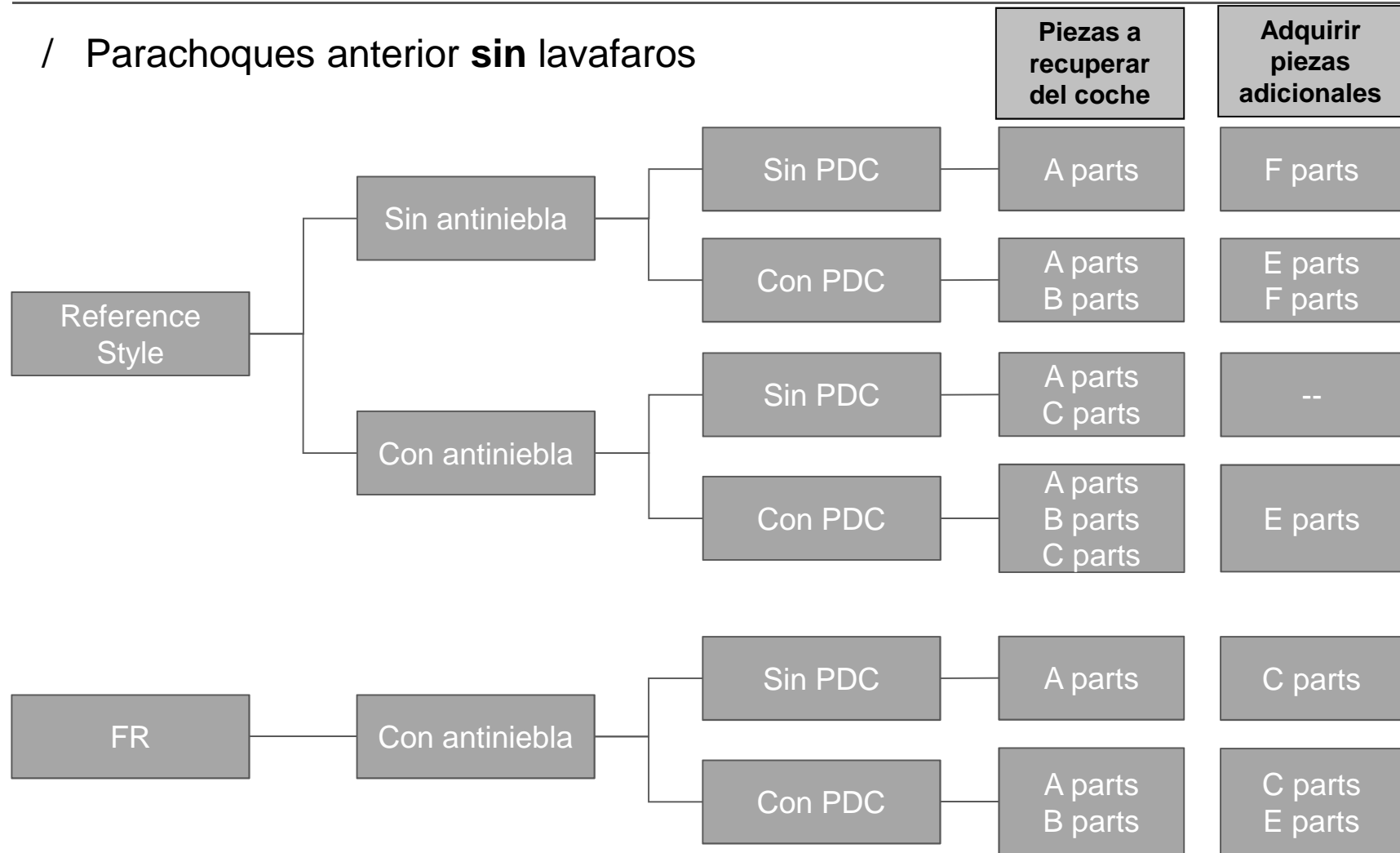

SE37X - KIT AERODINÁMICO

PARACHOQUES ANTERIOR CON LAVAFAROS – 5F0.071.060.A

/ Componentes

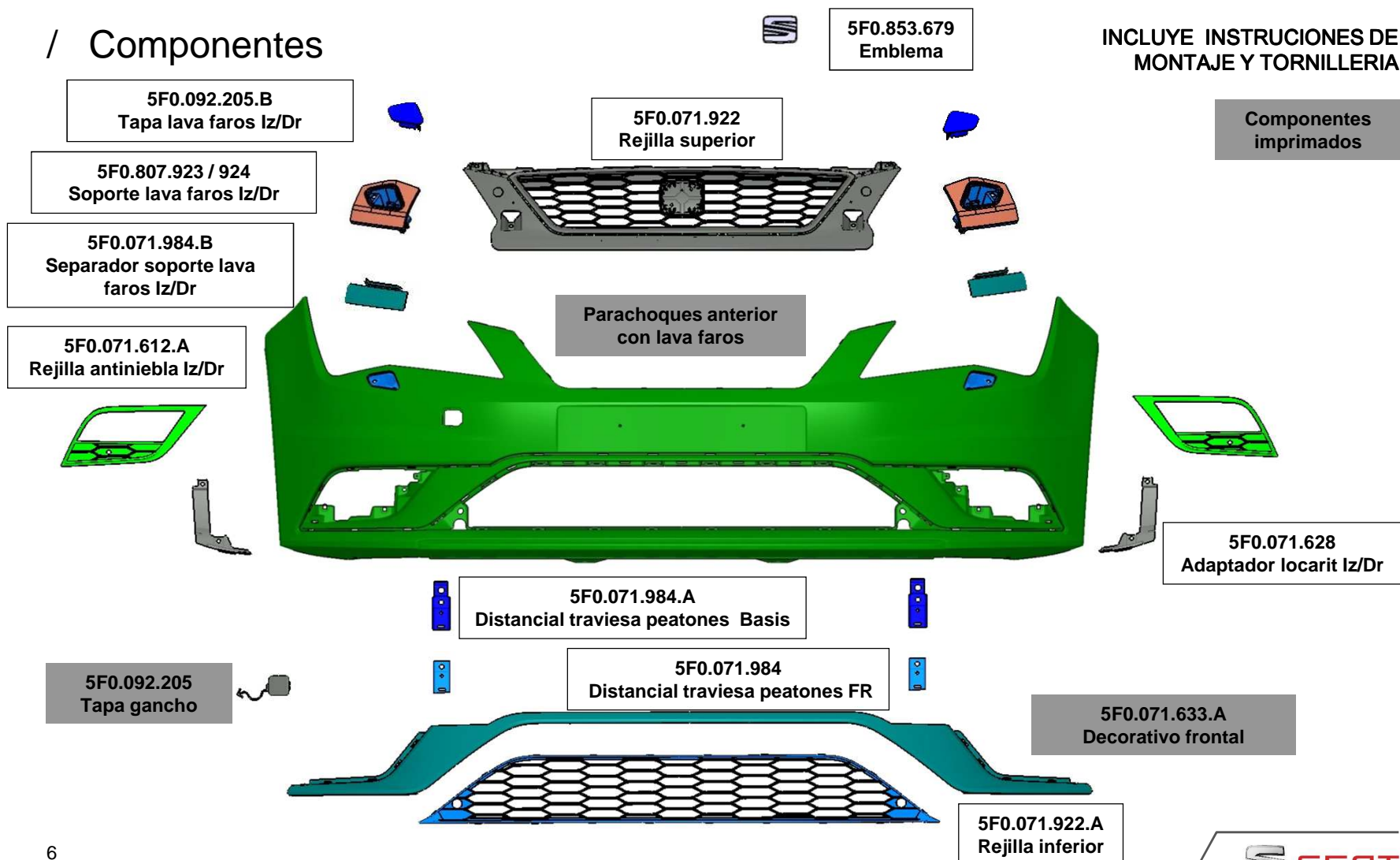

SE37X - KIT AERODINÁMICO

CONFIGURACIONES PARACHOQUES ANTERIOR – 5F0.071.060.A

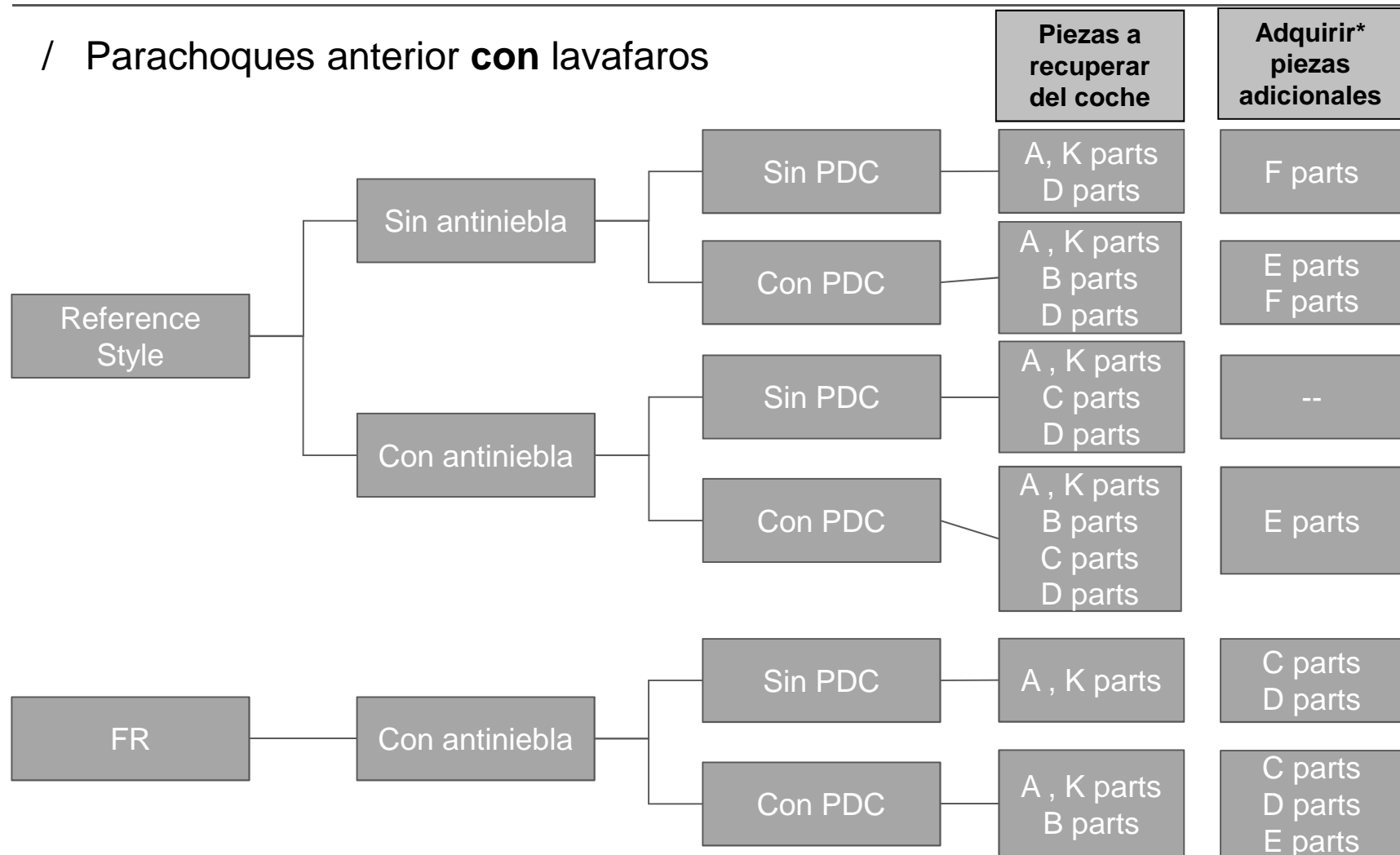

SE37X - KIT AERODINÁMICO

CONFIGURACIONES PARACHOQUES ANTERIOR

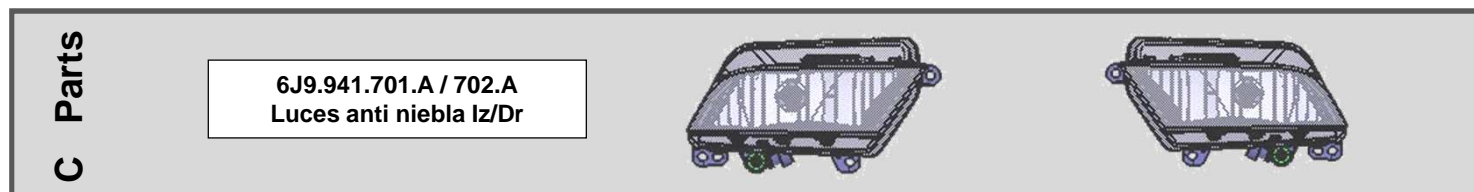
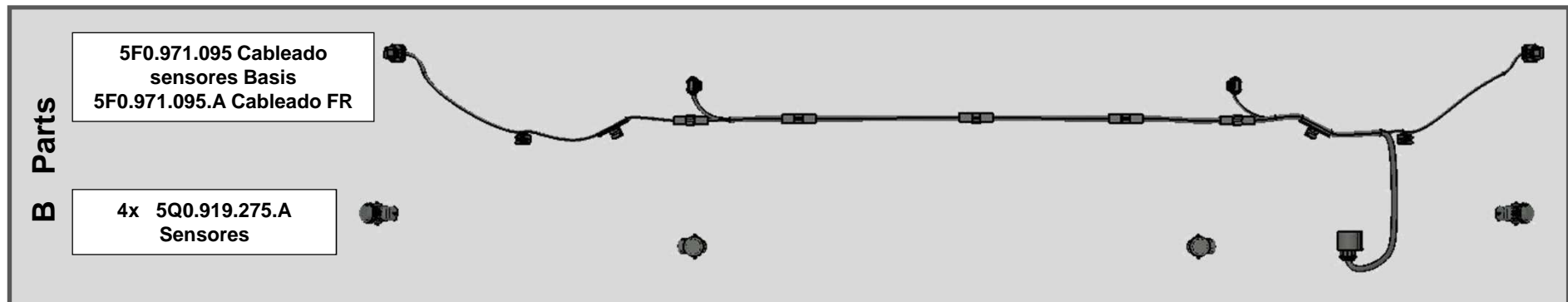
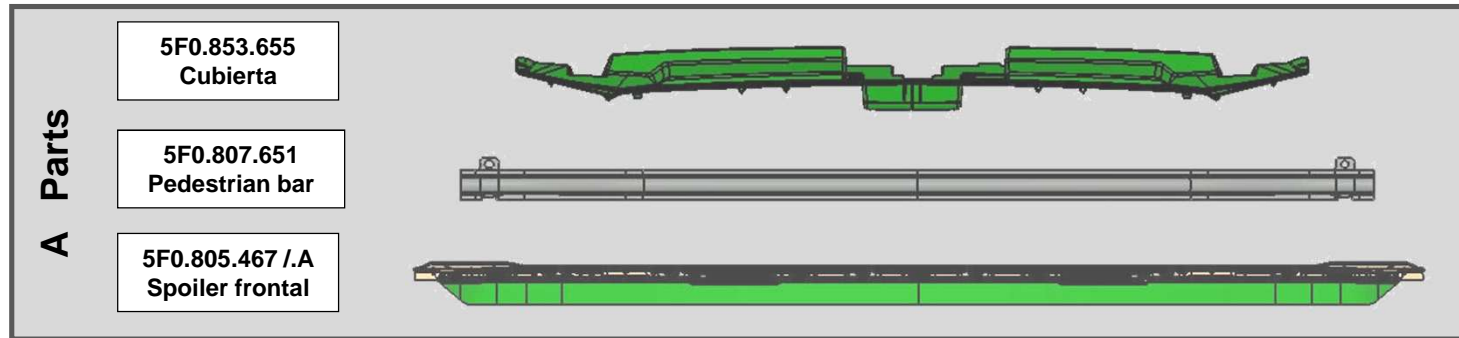

SE37X - KIT AERODINÁMICO

CONFIGURACIONES PARACHOQUES ANTERIOR

D Parts

5F0.807.595 / 596
Soporte cilindro lava faros Iz/Dr

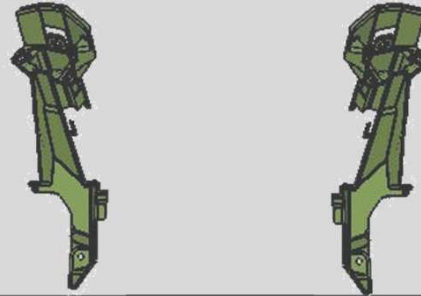

E Parts

5F0.919.487 / A / B / C
Soporte y tapa sensores



F Parts

5F0.092.205.G
Tapa anti nieblas IZ/Dr

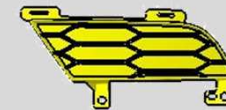
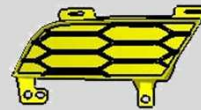

K Parts

5F0.955.970.A
Tubo lava faros

5F0.955.965 / 966
Cilindro Iz/Dr



SE37X - KIT AERODINÁMICO

CONFIGURACIÓN CONCESIONARIO

01 Parachoques anterior

02 Parachoques posterior

03 Taloneras

04 Spoiler

SE37X - KIT AERODINÁMICO

PARACHOQUES POSTERIOR – 5F0.071.609

/ Componentes

INCLUYE INSTRUCCIONES DE
MONTAJE Y TORNILLERIA

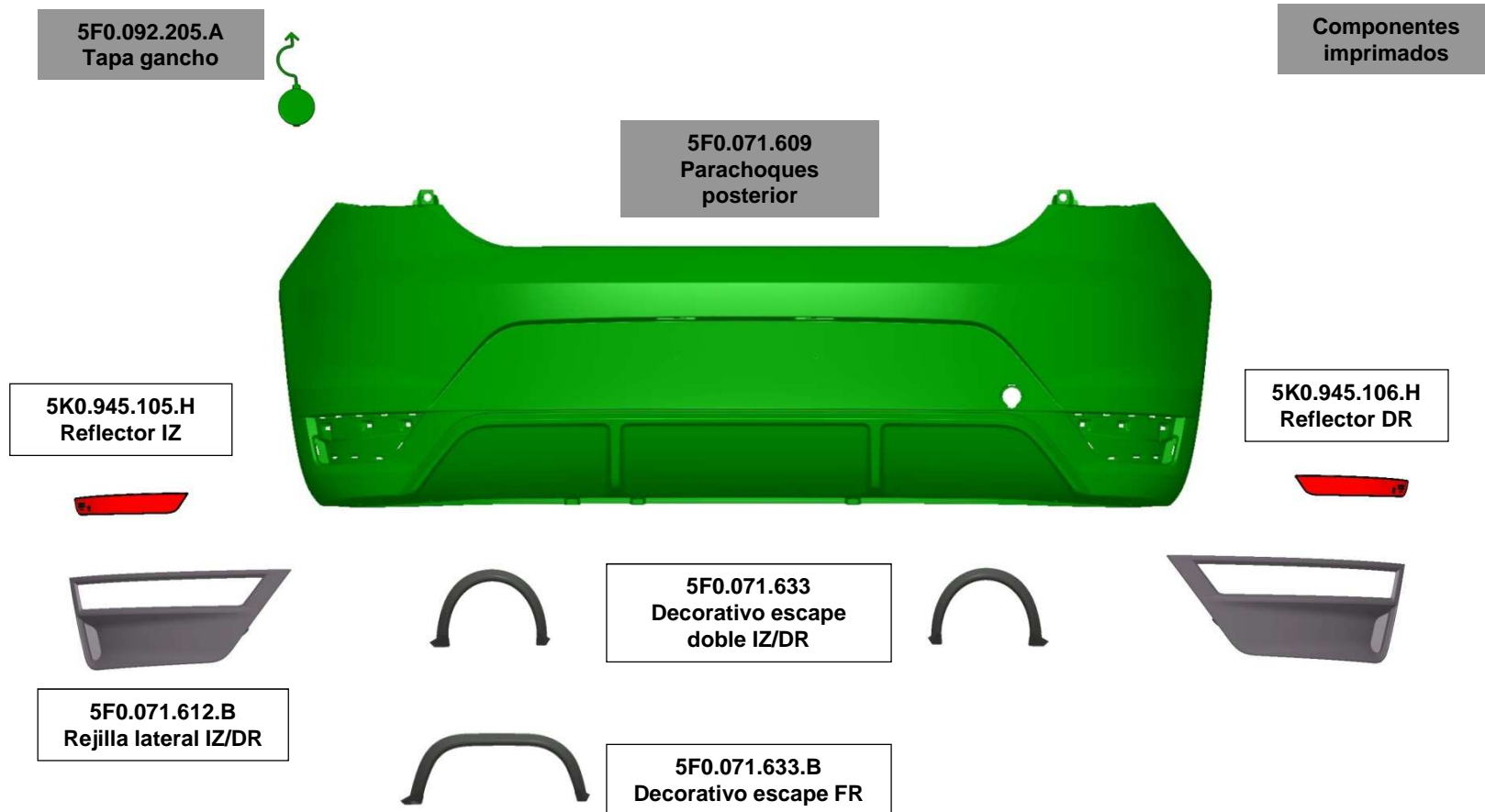

SE37X - KIT AERODINÁMICO

CONFIGURACIONES PARACHOQUES POSTERIOR – 5F0.071.609

/ Sensor de parking

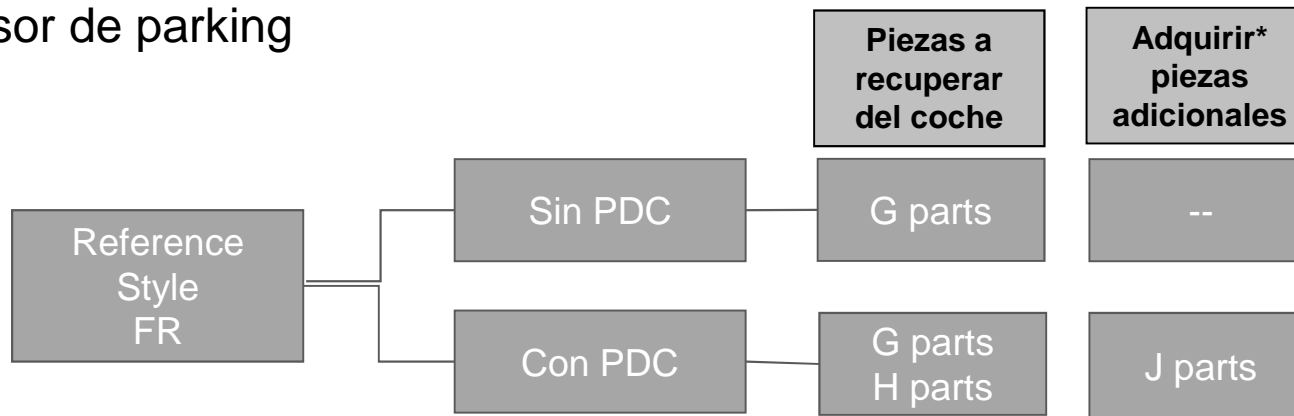

* Ordenar a través de recambios

/ Retrabajo salida escape

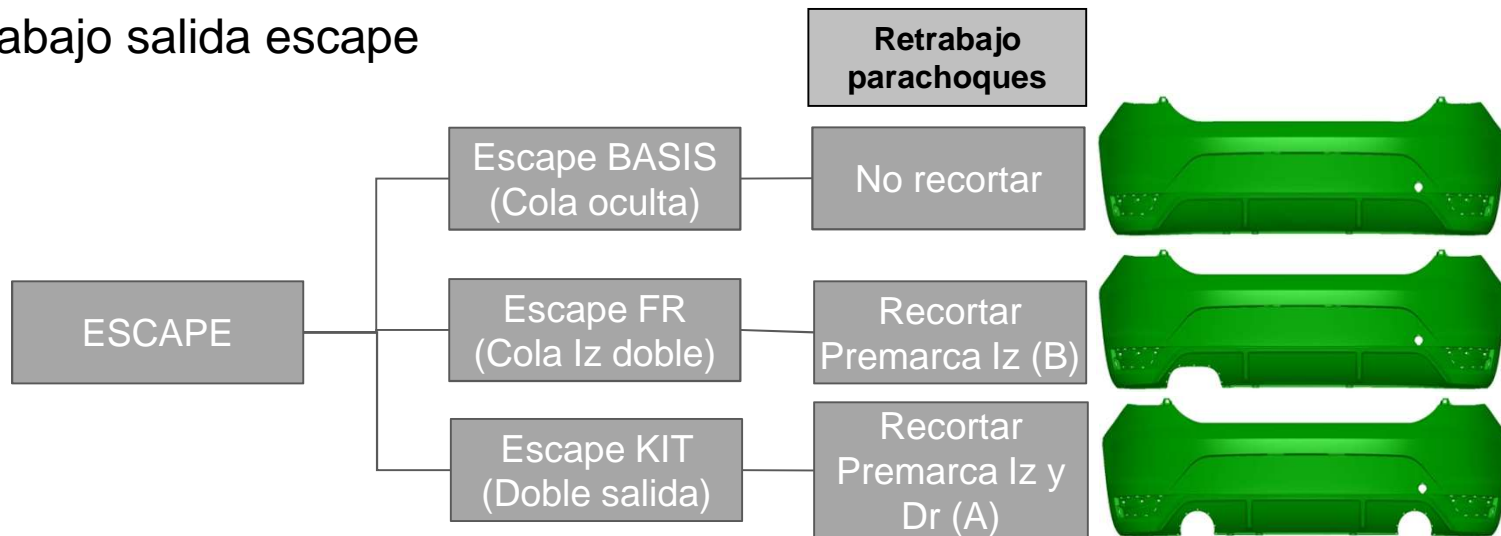

SE37X - KIT AERODINÁMICO

CONFIGURACIONES PARACHOQUES POSTERIOR – 5F0.071.609

G Parts

5F0.807.377 / 378
Soporte de fijación IZ/DR

2x 1K8.943.021
Luz matrícula

Para vehículos con faros halógenos

2x 1K8.943.021.C
Luz matrícula LED

Para vehículos con faros LED

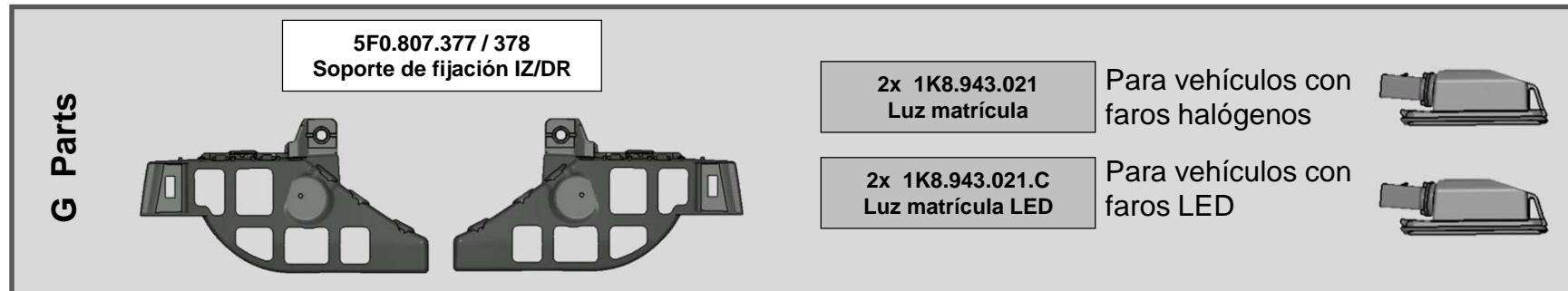

The diagram for G Parts shows two identical mounting brackets for license plate lights. To the right, two license plate light assemblies are shown: one for halogen headlights and one for LED headlights.

H Parts

4x 5Q0.919.275
Sensores

5F4.971.194
Cableado sensores

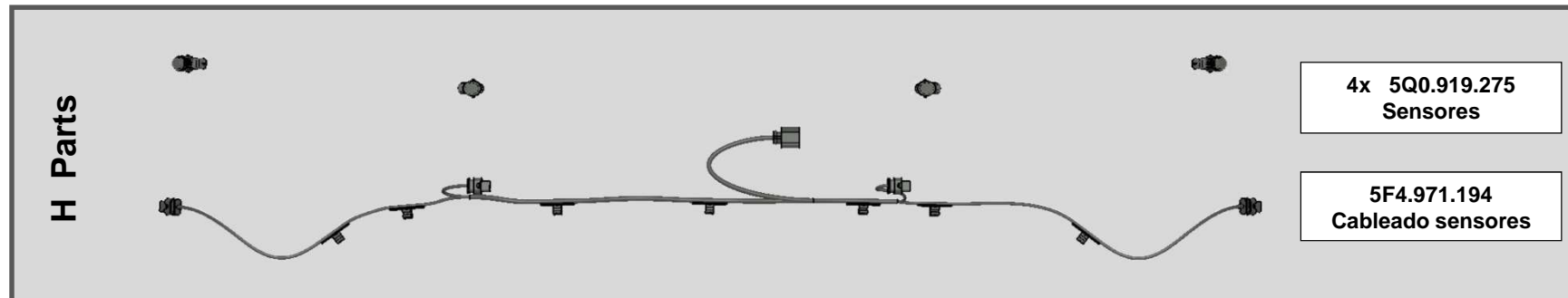

The diagram for H Parts shows a long sensor cable with four sensors attached at regular intervals. The cable has connectors at both ends.

J Parts

5F0.919.486 / A / B / C
Soporte y tapa sensores

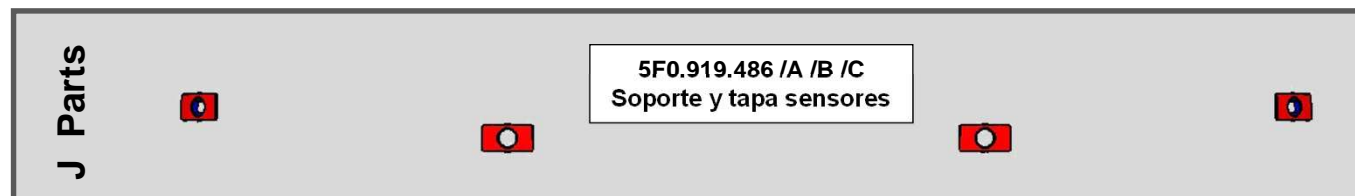

The diagram for J Parts shows four red square components, which are sensor supports and covers, arranged in a horizontal line.

SE37X - KIT AERODINÁMICO

CONFIGURACIÓN CONCESIONARIO

01 Parachoques anterior

02 Parachoques posterior

03 Taloneras

04 Spoiler

SE37X - KIT AERODINÁMICO

TALONERAS 5P – 5F0.071.610

INCLUYE INSTRUCCIONES DE
MONTAJE Y TORNILLERÍA

Componentes
imprimados

PEDIR ADICIONALMENTE 2 TUBOS
DE COLA REF: 000.071.785.A

Talonerías Iz/Dr

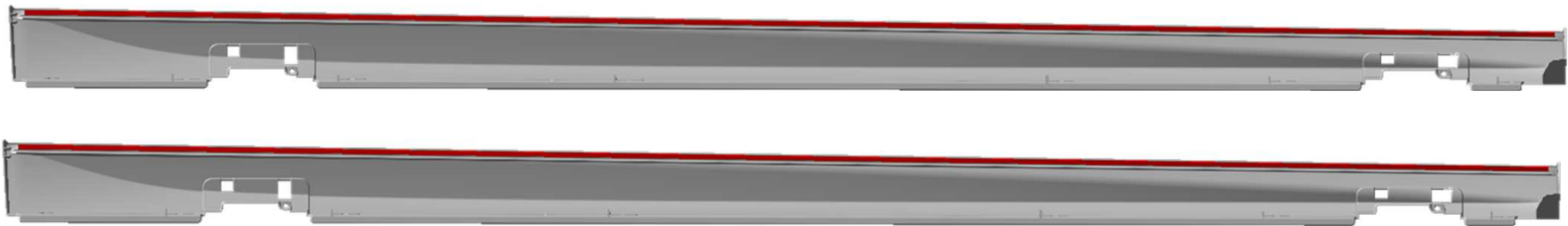

5F0.092.205.E
Cubierta posterior Iz/Dr



5F0.092.205.C
Cubierta anterior Iz/Dr



SE37X - KIT AERODINÁMICO

TALONERAS 3P – 5F0.071.610.A

INCLUYE INSTRUCCIONES DE
MONTAJE Y TORNILLERÍA

Componentes
imprimados

Talonerás Iz/Dr

PEDIR ADICIONALMENTE 2 TUBOS
DE COLA REF: 000.071.785.A

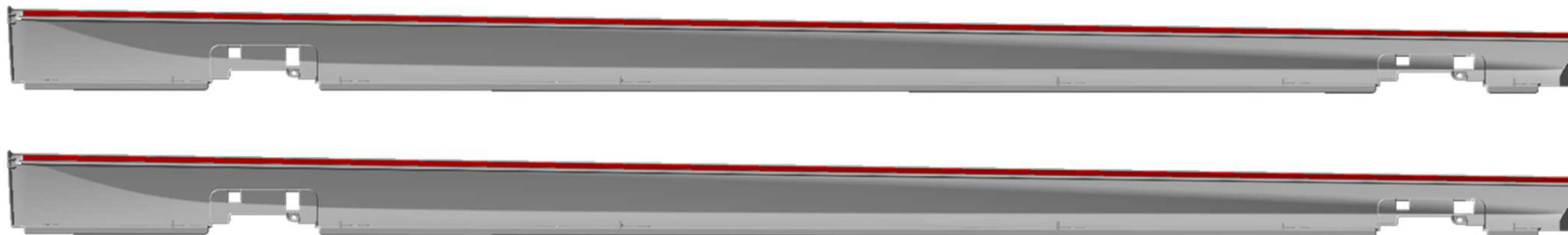

5F0.092.205.D
Cubierta posterior Iz/Dr



5F0.092.205.C
Cubierta anterior Iz/Dr



SE37X - KIT AERODINÁMICO

CONFIGURACIÓN CONCESIONARIO

01 Parachoques anterior

02 Parachoques posterior

03 Taloneras

04 Spoiler

SE37X - KIT AERODINÁMICO

SPOILER 5P – 5F0.071.606.A

INCLUYE INSTRUCCIONES DE
MONTAJE Y TORNILLERIA

Componentes
imprimados

PEDIR ADICIONALMENTE TUBO
DE COLA REF: 000.071.785.A

Spoiler 5P



SE37X - KIT AERODINÁMICO

SPOILER 3P – 5F0.071.606.B

INCLUYE INSTRUCCIONES DE
MONTAJE Y TORNILLERIA

Componentes
imprimados

PEDIR ADICIONALMENTE TUBO
DE COLA REF: 000.071.785.A

Spoiler 3P

